

DELGARD™ PREMIER ALUMINUM FENCING

DELGARD PREMIER ALUMINUM FENCING
8600 RIVER ROAD, DELAIR, NJ, 08110
TOLL FREE: 1-800-235-0185
PHONE: (856) 663-2900
FAX: (856) 663-1297
www.delgard.com

- SIZE (H) COLOR
- 54" BLACK
- BRONZE
- HUNTER GREEN
- SANDSTONE
- WHITE
- PICKET STYLE STYLE
- ARCHED DOUBLE
- STRAIGHT SINGLE









A	B	C	D
36"	54"	48 1/2"	60"
OR			
48"			

SINGLE GATE

A	B	C	D	E
96"	82"	54"	47"	21"
OR				
120"				

DOUBLE GATE

ACCESSORIES

-  ALUMINUM POST CAPS
-  BALL CAPS
-  BASE FLANGE
-  WELDED BASE FLANGE
-  BUTTERFLY SCROLL
-  ESTATE SCROLL
-  CIRCLE (INSTALLED)
-  ROYAL FINIAL
-  TRIAD

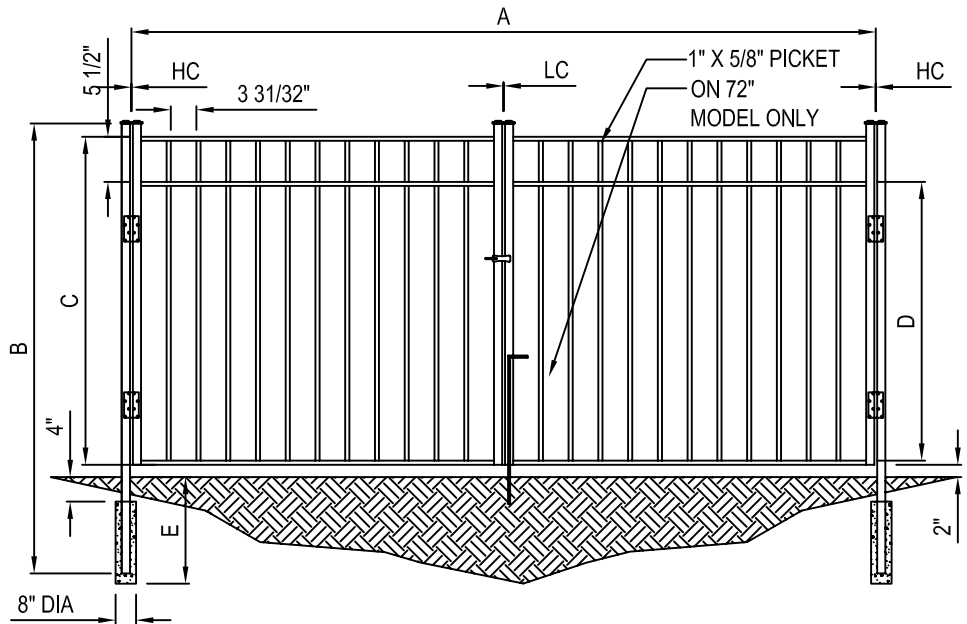

DOUBLE GATE

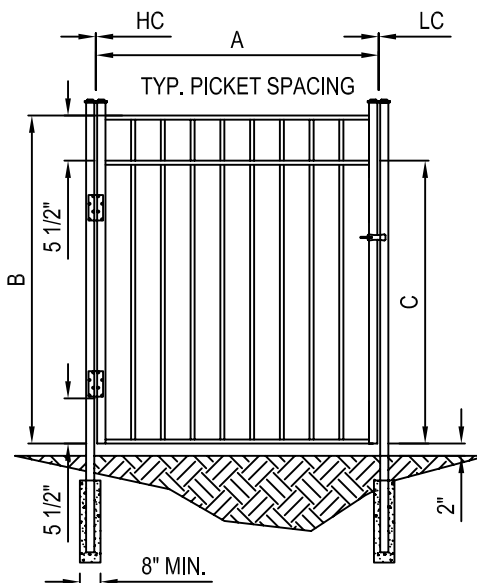

STRAIGHT STYLE

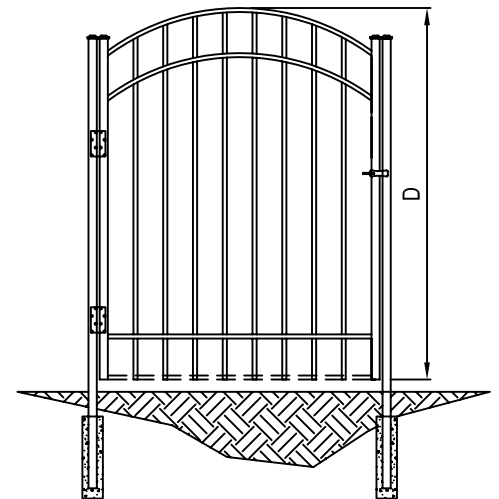

ARCHED STYLE

NOTES:

1. INSTALLATION TO BE COMPLETED IN ACCORDANCE WITH MANUFACTURER'S SPECIFICATIONS.
2. ALL DIMENSIONS ARE CONSIDERED TRUE AND REFLECT MANUFACTURER'S SPECIFICATIONS.
3. DO NOT SCALE DRAWING.
4. CONTRACTOR'S NOTE: FOR PRODUCT AND COMPANY INFORMATION VISIT www.CADdetails.com/info REFERENCE NUMBER 4140-040.

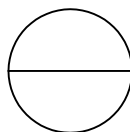

AERO GRADE FENCES & GATES
GUARDIAN ELBA AERO GATE